

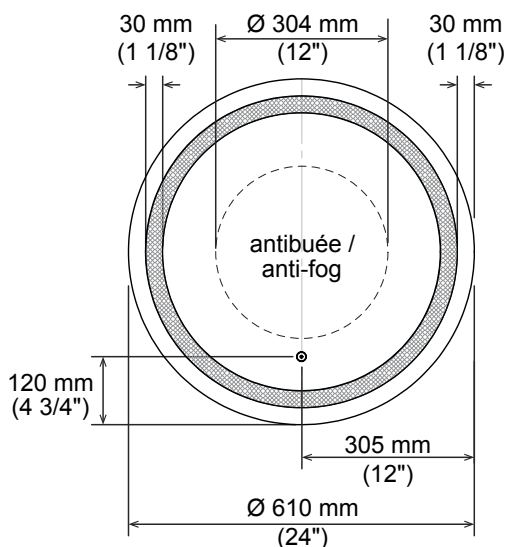

# Effect

Illuminated LED mirror with interior frosted Strip



-  Frosted Strip
-  Touch switch

## FEATURES

Code	<b>MR1660-500-001</b>
Packaging mm (in)	<b>730 x 730 x 90 (28.7 x 28.7 x 3.5)</b>
Mirror thickness	<b>4 mm</b>
Weight kg (lb)	<b>7.1 (15.4)</b>
Certification	<b>cUL<sub>us</sub></b>
Anti-fog system	<b>Included</b>
Magnifying mirror (3X)	<b>Not available</b>
Reversible	<b>No</b>
Total thickness	<b>44 mm +/- 1 mm (1 3/4")</b>

## LIGHTING

Power (watt)	<b>28 W</b>
Input (volt)	<b>120 V</b>
Dimmable	<b>No</b>
Lumens	<b>1100 lm</b>
2 tones touch switch	<b>3000k (warm white) 5000k (cool blue)</b>
Frequency	<b>60 Hz</b>
Color Rendering Index (CRI)	<b>90+</b>