

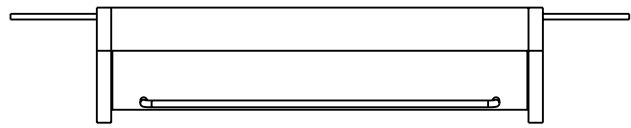

	ITEM:	SPR		MATERIAL:
	FINISH:			WEIGHT: 9
<b>PROPRIETARY AND CONFIDENTIAL</b> THE INFORMATION CONTAINED IN THIS DRAWING IS THE SOLE PROPERTY OF HARDWARE RESOURCES INC. ANY REPRODUCTION IN PART OR AS A WHOLE WITHOUT THE WRITTEN PERMISSION OF HARDWARE RESOURCES INC. IS PROHIBITED.	TOLERANCE UNLESS OTHERWISE SPECIFIED:	UNIT:	DRAWN BY:	DATE:
	X: MM ±0.20	SIZE:	<i>alan.liu</i>	DATE:
	X.X: MM ±0.10		CHECKED BY:	DATE:
	X.XX: MM ±0.05		APPROVED BY:	DATE:
	ANGULAR: ±0.5°			
	DO NOT SCALE DRAWING			

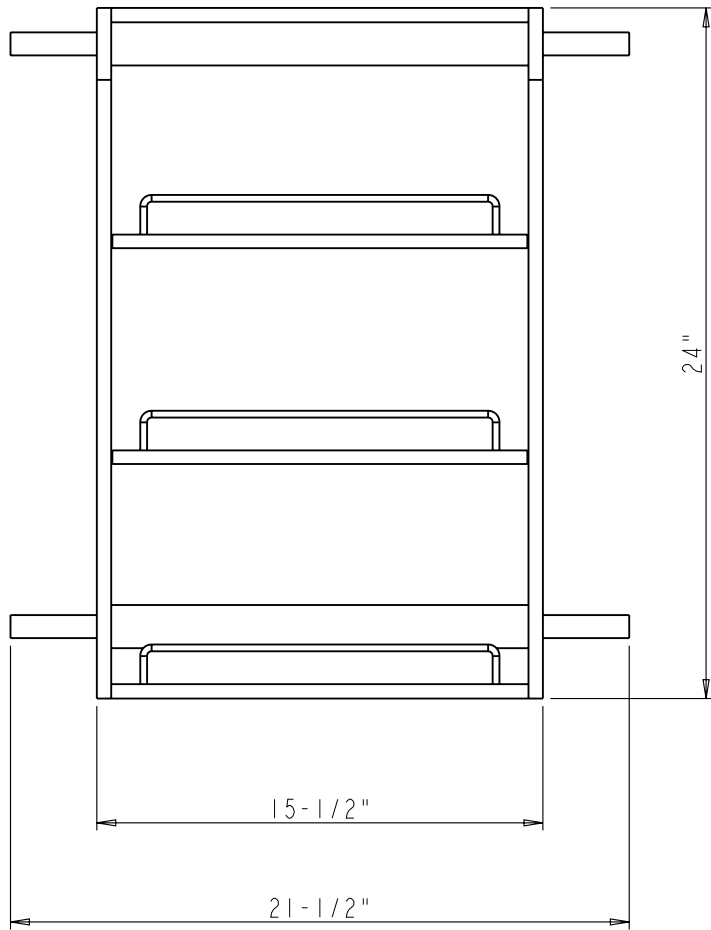

	ITEM#: SPR15		MATERIAL:		
	FINISH:		WEIGHT: 9		
<p><b>PROPRIETARY AND CONFIDENTIAL</b></p> <p>THE INFORMATION CONTAINED IN THIS DRAWING IS THE SOLE PROPERTY OF HARDWARE RESOURCES INC. ANY REPRODUCTION IN PART OR AS A WHOLE WITHOUT THE WRITTEN PERMISSION OF HARDWARE RESOURCES INC. IS PROHIBITED.</p>	<p>TOLERANCE UNLESS OTHERWISE SPECIFIED:</p> <p>X : MM ±0.20</p> <p>X.X : MM ±0.10</p> <p>X.XX : MM ±0.05</p> <p>ANGULAR: ±0.5°</p> <p>DO NOT SCALE DRAWING</p>		<p>UNIT:</p>	<p>DRAWN BY:</p> <p><i>alan.liu</i></p>	<p>DATE:</p>
	<p>SIZE:</p>	<p>CHECKED BY:</p>	<p>DATE:</p>	<p>DATE:</p>	<p>DATE:</p>
	<p>APPROVED BY:</p>	<p>DATE:</p>	<p>DATE:</p>	<p>DATE:</p>	<p>DATE:</p>
	<p>PROJECTION:</p> 	<p>DATE:</p>	<p>DATE:</p>	<p>DATE:</p>	<p>DATE:</p>

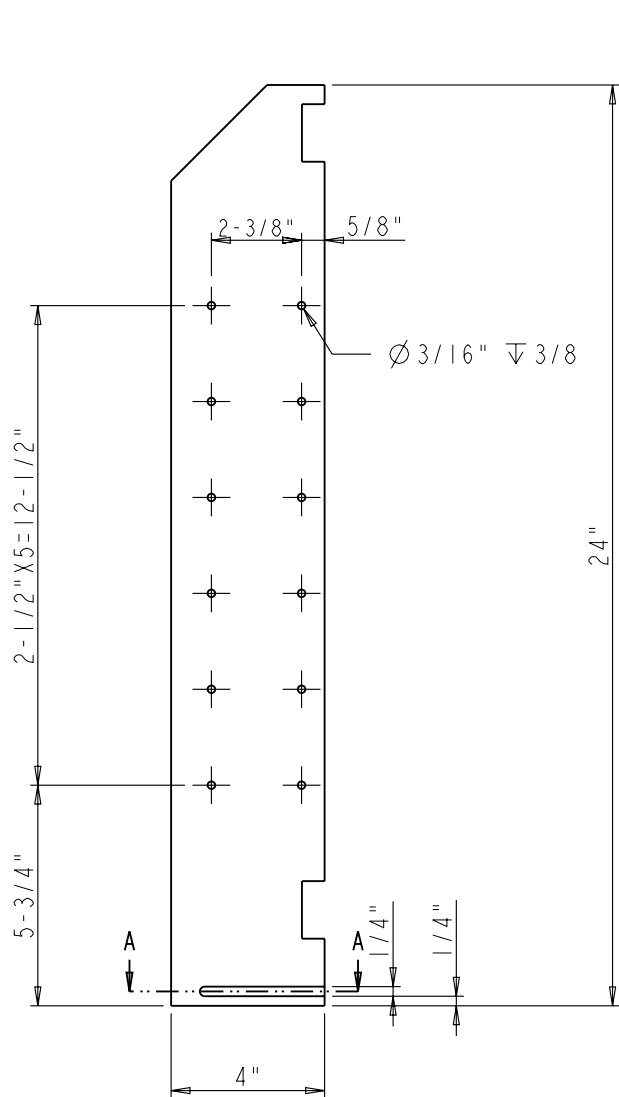

FRONT VIEW

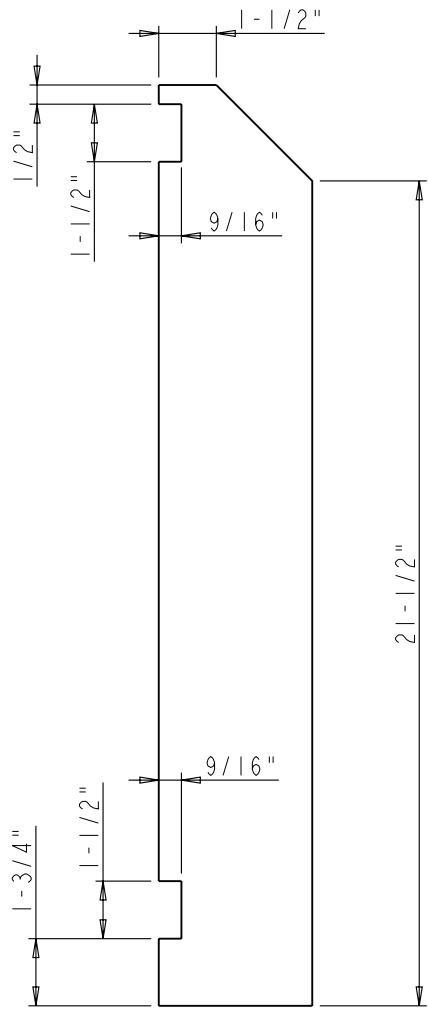

REAR VIEW

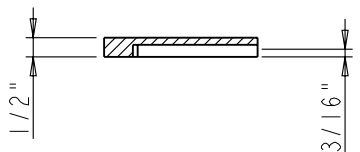
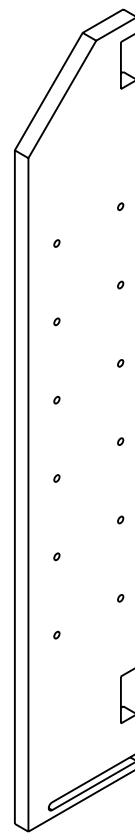

SECTION A-A

Note:

- 1. The part " side board right " is a mirrored part of " side board left "

	ITEM: SIDE-BOARD-LEFT		MATERIAL:		
	FINISH:		WEIGHT: 9		
PROPRIETARY AND CONFIDENTIAL THE INFORMATION CONTAINED IN THIS DRAWING IS THE SOLE PROPERTY OF HARDWARE RESOURCES INC. ANY REPRODUCTION IN PART OR AS A WHOLE WITHOUT THE WRITTEN PERMISSION OF HARDWARE RESOURCES INC. IS PROHIBITED.	TOLERANCE UNLESS OTHERWISE SPECIFIED: X: MM ±0.20 XX: MM ±0.10 XXX: MM ±0.05 ANGULAR: ±0.5° DO NOT SCALE DRAWING		UNIT:	DRAWN BY: <i>alan.liu</i>	DATE:
	SIZE:	CHECKED BY:	DATE:		
	APPROVED BY:		DATE:		
	PROJECTION:				

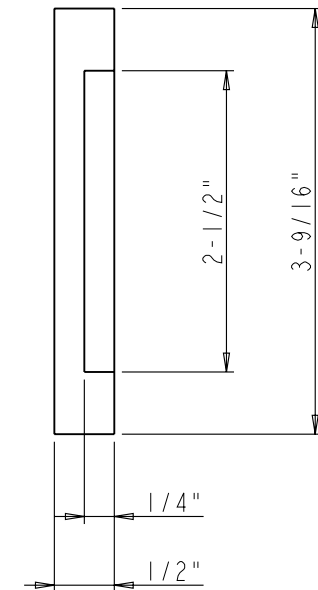
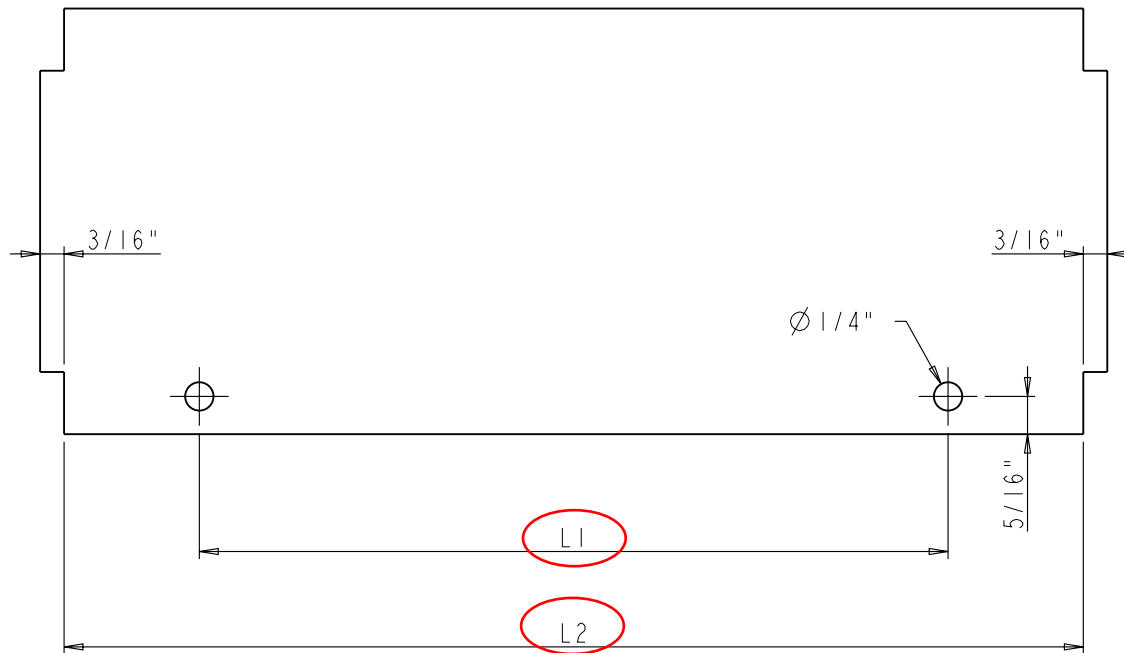

Note:

1. In Shelf-board-9, L1 is 6-1/4", L2 is 8-1/2"
2. In Shelf-board-12, L1 is 9-1/4", L2 is 11-1/2"
3. In Shelf-board-15, L1 is 12-1/4", L2 is 14-1/2"

<b>hardware resources</b> PROPRIETARY AND CONFIDENTIAL THE INFORMATION CONTAINED IN THIS DRAWING IS THE SOLE PROPERTY OF HARDWARE RESOURCES INC. ANY REPRODUCTION IN PART OR AS A WHOLE WITHOUT THE WRITTEN PERMISSION OF HARDWARE RESOURCES INC. IS PROHIBITED.	ITEM#	SHELF-BOARD		MATERIAL:
	FINISH:			WEIGHT: 9
	TOLERANCE UNLESS OTHERWISE SPECIFIED: X: MM $\pm 0.20$ XX: MM $\pm 0.10$ XXX: MM $\pm 0.05$ ANGULAR: $\pm 0.5^\circ$ DO NOT SCALE DRAWING	UNIT:	DRAWN BY: <i>alan.liu</i>	DATE:
	SIZE:	CHECKED BY:	DATE:	DATE:
	APPROVED BY:	DATE:	DATE:	DATE:

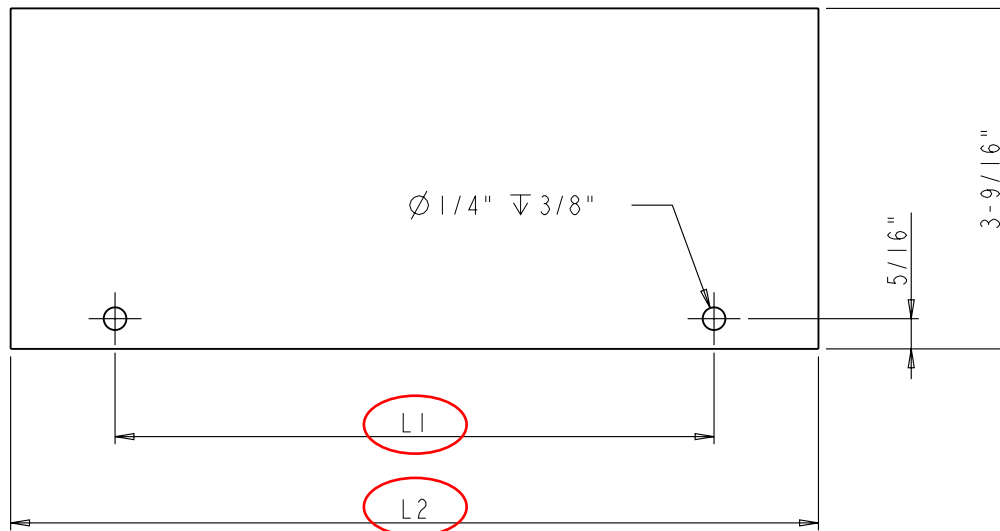

TOP VIEW

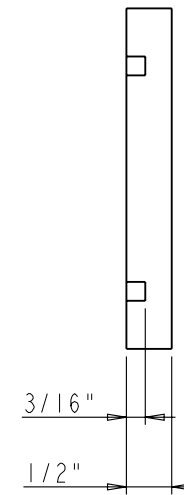

SIDE VIEW



BOTTOM VIEW

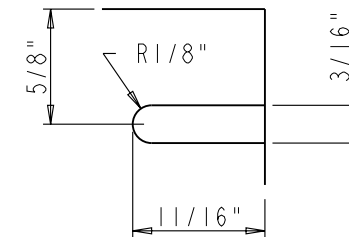

DETAIL A  
SCALE 1:1

Note:

1. In Adjustable-Board-9, L1 is 6-1/4", L2 is 8-7/16"
2. In Adjustable-Board-12, L1 is 9-1/4", L2 is 11-7/16"
3. In Adjustable-Board-15, L1 is 12-1/4", L2 is 14-7/16"

	ITEM#: ADJUSTABLE-BOARD		MATERIAL:		
	FINISH:		WEIGHT: 9		
<b>PROPRIETARY AND CONFIDENTIAL</b> THE INFORMATION CONTAINED IN THIS DRAWING IS THE SOLE PROPERTY OF HARDWARE RESOURCES INC. ANY REPRODUCTION IN PART OR AS A WHOLE WITHOUT THE WRITTEN PERMISSION OF HARDWARE RESOURCES INC. IS PROHIBITED.	TOLERANCE UNLESS OTHERWISE SPECIFIED: X: MM ±0.20 XX: MM ±0.10 XXX: MM ±0.05 ANGULAR: ±0.5° DO NOT SCALE DRAWING		UNIT:	DRAWN BY: <i>alan.liu</i>	DATE:
	SIZE:	CHECKED BY:	APPROVED BY:	DATE:	DATE:
	PROJECTION:				

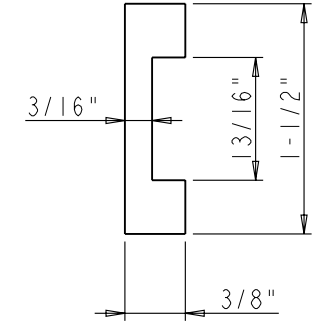
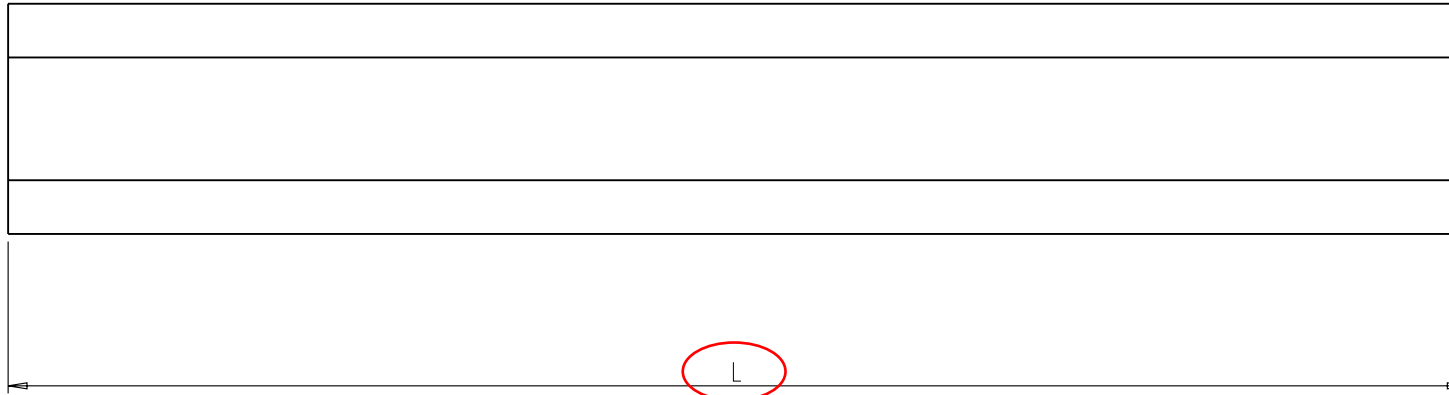

Note:

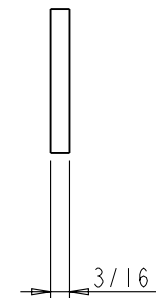
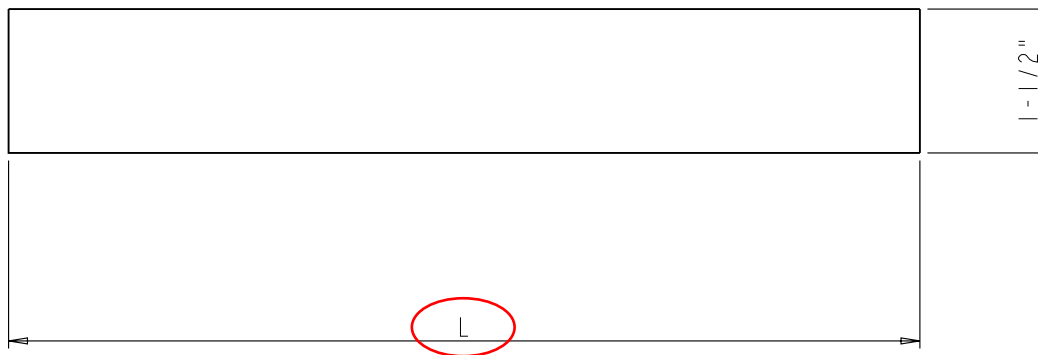

1. The dimension " L " of support bar for SPR9 is 9-1/2";
2. The dimension " L " of support bar for SPR12 is 12-1/2";
3. The dimension " L " of support bar for SPR15 is 15-1/2";

	ITEM: SUPPORT-BAR		MATERIAL:		
	FINISH:		WEIGHT: 9		
<b>PROPRIETARY AND CONFIDENTIAL</b> THE INFORMATION CONTAINED IN THIS DRAWING IS THE SOLE PROPERTY OF HARDWARE RESOURCES INC. ANY REPRODUCTION IN PART OR AS A WHOLE WITHOUT THE WRITTEN PERMISSION OF HARDWARE RESOURCES INC. IS PROHIBITED	TOLERANCE UNLESS OTHERWISE SPECIFIED: X : MM ±0.20 X.X : MM ±0.10 X.XX : MM ±0.05 ANGULAR: ±0.5° DO NOT SCALE DRAWING		UNIT:	DRAWN BY: <i>alan.liu</i>	DATE:
	SIZE:	CHECKED BY:	DATE:		
	APPROVED BY:		DATE:		
	PROJECTION:				



Note:

1. The dimension " L " of REAR-BOARD for SPR9 is 9-1/2";
2. The dimension " L " of REAR-BOARD for SPR12 is 12-1/2";
3. The dimension " L " of REAR-BOARD for SPR15 is 15-1/2";

	ITEM#: REAR-BOARD		MATERIAL:		
	FINISH:		WEIGHT: 9		
<b>PROPRIETARY AND CONFIDENTIAL</b> THE INFORMATION CONTAINED IN THIS DRAWING IS THE SOLE PROPERTY OF HARDWARE RESOURCES INC. ANY REPRODUCTION IN PART OR AS A WHOLE WITHOUT THE WRITTEN PERMISSION OF HARDWARE RESOURCES INC. IS PROHIBITED.	TOLERANCE UNLESS OTHERWISE SPECIFIED: X : MM ±0.20 X.X : MM ±0.10 X.XX : MM ±0.05 ANGULAR: ±0.5° DO NOT SCALE DRAWING		UNIT:	DRAWN BY: <i>alan.liu</i>	DATE:
	SIZE:	CHECKED BY:	DATE:		
	APPROVED BY:		DATE:		
	PROJECTION: 				

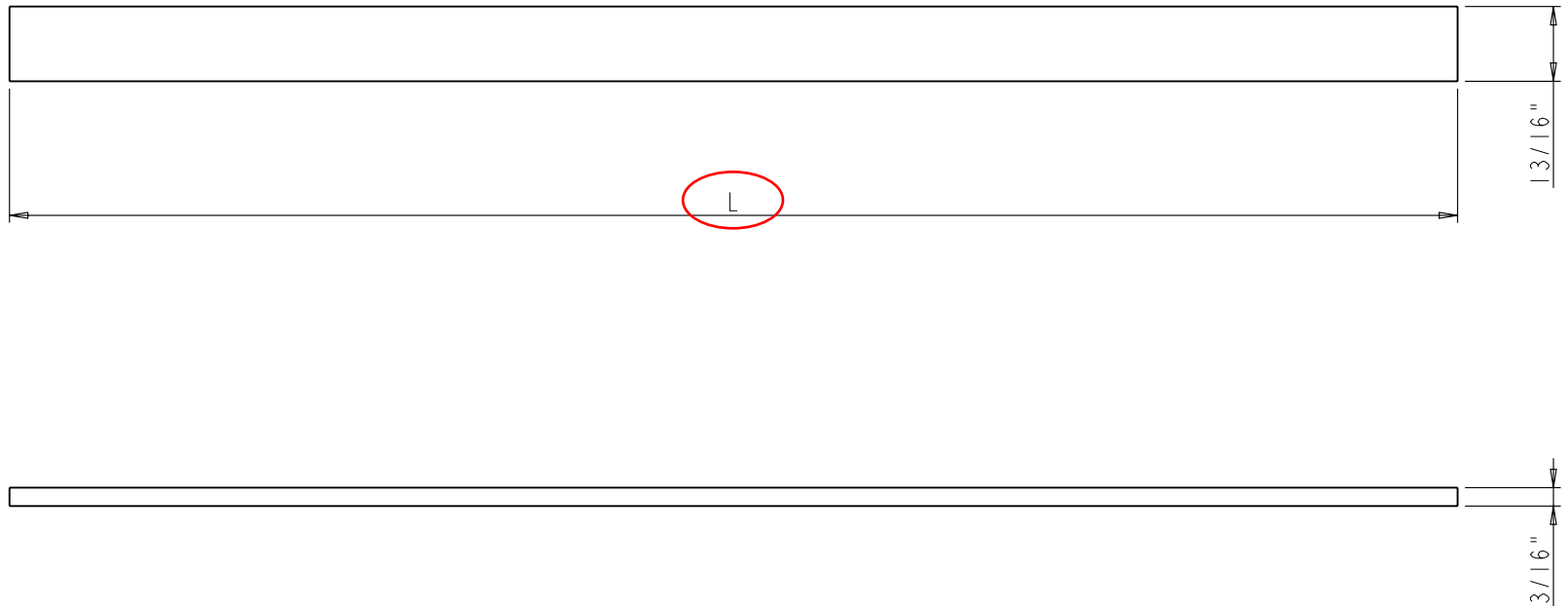

Note:

1. The dimension " L " of WOOD-BAR for SPR9 is 15-1/2";
- ~~2. The dimension " L " of WOOD-BAR for SPR12 is 18-1/2";~~
- ~~3. The dimension " L " of WOOD-BAR for SPR15 is 21-1/2";~~

	ITEM: WOOD-BAR		MATERIAL:		
	FINISH:		WEIGHT: 9		
<b>PROPRIETARY AND CONFIDENTIAL</b> THE INFORMATION CONTAINED IN THIS DRAWING IS THE SOLE PROPERTY OF HARDWARE RESOURCES INC. ANY REPRODUCTION IN PART OR AS A WHOLE WITHOUT THE WRITTEN PERMISSION OF HARDWARE RESOURCES INC. IS PROHIBITED.	TOLERANCE UNLESS OTHERWISE SPECIFIED: X : MM ±0.20 X.X : MM ±0.10 X.XX : MM ±0.05 ANGULAR: ±0.5° DO NOT SCALE DRAWING		UNIT:	DRAWN BY: <i>alan.liu</i>	DATE:
	SIZE:	CHECKED BY:	DATE:		
	APPROVED BY:		DATE:		
	PROJECTION:				



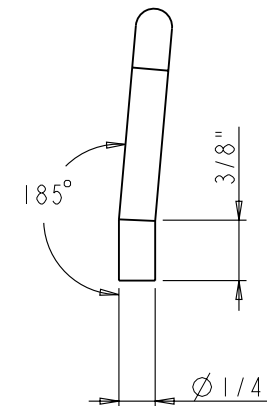
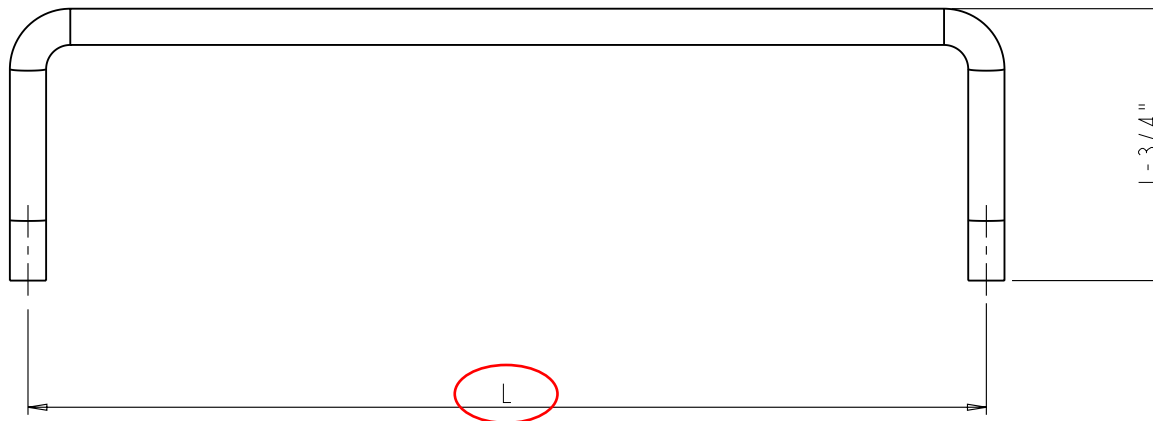

Note:

1. In Stick-9, L is 6-1/4"
2. In Stick-12, L is 9-1/4"
3. In Stick-15, L is 12-1/4"

	ITEM: STICK		MATERIAL:		
	FINISH:		WEIGHT: 9		
<b>PROPRIETARY AND CONFIDENTIAL</b> THE INFORMATION CONTAINED IN THIS DRAWING IS THE SOLE PROPERTY OF HARDWARE RESOURCES INC. ANY REPRODUCTION IN PART OR AS A WHOLE WITHOUT THE WRITTEN PERMISSION OF HARDWARE RESOURCES INC. IS PROHIBITED.	TOLERANCE UNLESS OTHERWISE SPECIFIED: X: MM ±0.20 X.X: MM ±0.10 X.XX: MM ±0.05 ANGULAR: ±0.5° DO NOT SCALE DRAWING		UNIT:	DRAWN BY: <i>alan.liu</i>	DATE:
	SIZE:	CHECKED BY:	DATE:		
	APPROVED BY:		DATE:		
	PROJECTION:				

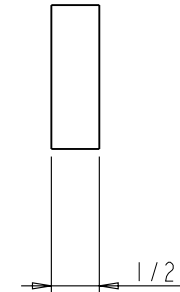
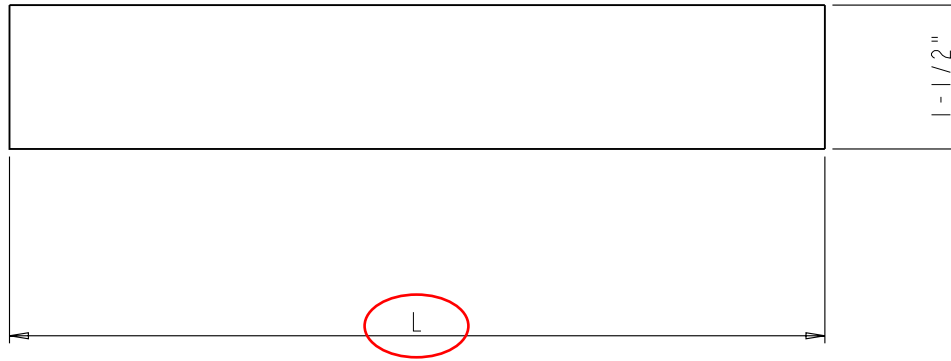

Note:

1. The dimension " L " of for SPR9 is 8-1/2";
2. The dimension " L " of for SPR12 is 11-1/2";
3. The dimension " L " of for SPR15 is 14-1/2";

	ITEM#: STRENGTHEN-BOARD		MATERIAL:		
	FINISH:		WEIGHT: 9		
<b>PROPRIETARY AND CONFIDENTIAL</b> THE INFORMATION CONTAINED IN THIS DRAWING IS THE SOLE PROPERTY OF HARDWARE RESOURCES INC. ANY REPRODUCTION IN PART OR AS A WHOLE WITHOUT THE WRITTEN PERMISSION OF HARDWARE RESOURCES INC. IS PROHIBITED.	TOLERANCE UNLESS OTHERWISE SPECIFIED: X : MM ±0.20 X.X : MM ±0.10 X.XX : MM ±0.05 ANGULAR: ±0.5° DO NOT SCALE DRAWING		UNIT:	DRAWN BY: <i>alan.liu</i>	DATE:
	SIZE:	CHECKED BY:	DATE:		
	APPROVED BY:		DATE:		
	PROJECTION:				