

GROHE

WATER TECHNOLOGY

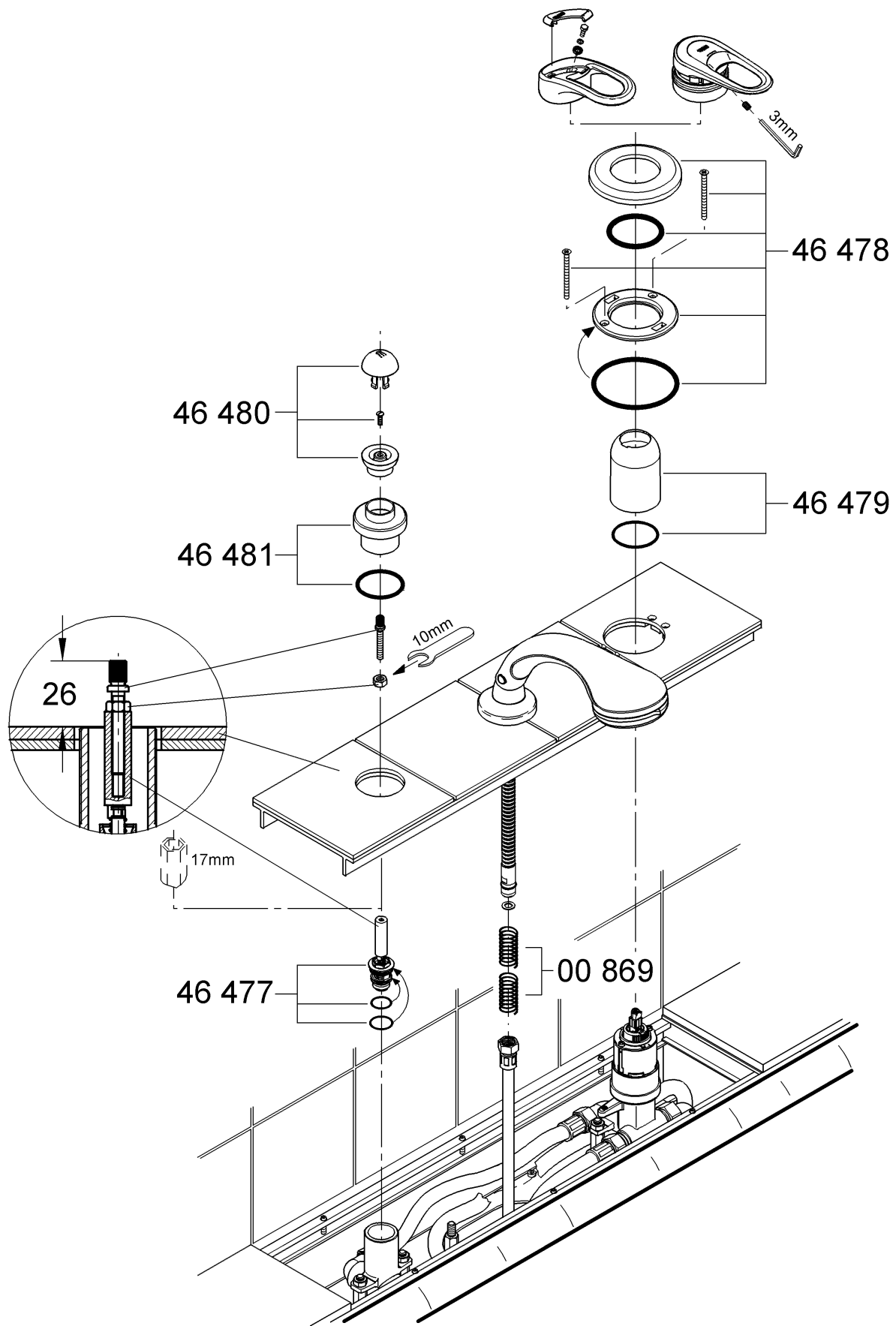

95.674.131/ÄM 22 139/10.01